

# ScanPal Series

## ScanPal EDA60K-0 Handheld Computer

Android™ 7.1



User Guide

## **Disclaimer**

Honeywell International Inc. (abbr. HII) reserves the rights to modify the specifications and other information mentioned in this User Guide without prior notification. In any case, users should confirm with HII whether any changes were made. This publication does not represent any commitments of HII.

HII is not responsible for any technical or editing errors or omissions contained in this manual, nor for any incidents or indirect damages caused by providing, implementing or using this material. HII is not responsible for the softwares or hardwares selected or used in order to achieve the desired results.

The proprietary information contained in this article is protected by copyright. All rights reserved. Without prior written consent from HII, any form of photocopy, copy or translation into other languages is not allowed.

## **Trademark Rights**

Android, Google and other marks are trademarks of Google Inc.

Other product names mentioned in this manual may be trademarks or registered trademarks of their respective companies, which are owned by these companies.

## **Patents**

For information on patents, please refer to [www.hsmpats.com](http://www.hsmpats.com).

Copyright © 2017 Honeywell International Inc. All rights reserved.

# Table of Contents

<b>1</b>	<b>Product Features of ScanPal EDA60K-0 Handheld Computer</b>	<b>1</b>
	About EDA60K-0 Handheld Computer	2
	Battery	6
	<i>Charging</i>	6
	<i>Replacing batteries</i>	7
	<i>Battery icon</i>	11
	<i>Changing power indicators</i>	13
	<i>Checking the remaining battery capacity</i>	14
	<i>Battery life and maintenance</i>	14
	<i>Battery maintenance recommendations and safety protection measures</i>	15
	<i>Enabling Airplane Mode</i>	15
	Power on	16
	Unlocking the screen	16
	Scanning Indicator	17
	Backlight for Setting Screen	17
	Backlight for Setting Button	18
	Audio features	18
	<i>Adjusting the ringtone volume for calls and messages</i>	18
	<i>Enabling vibration mode</i>	19
	<i>Audio settings</i>	21
	Inserting SD card	22
	File transfer	23
	How to view files on EDA60K-0	23
	EDA60K-0 Accessories	24
<b>2</b>	<b>Chapter 2: User Interface and Application</b>	<b>25</b>
	User interface	26
	<i>The main interface</i>	26
	<i>Status bar icons</i>	28
	<i>Key mapping</i>	28
	<i>Viewing system messages</i>	30
	<i>Managing system messages</i>	30
	<i>Personalizing the main interface</i>	31
	<i>Customizing common applications</i>	31
	<i>Touch screen gestures</i>	31
	<i>Setting timezones</i>	32
	Honeywell applications	33

	Download Enterprise Application Lock (Applock) .....	34
	Unlocking developer options .....	34
<b>3</b>	<b>Scanning Function .....</b>	<b>35</b>
	Scan Function.....	36
	<i>How to transfer data via Android keyboard input</i> .....	36
	<i>Changing scan settings</i> .....	37
	<i>Restoring default scan settings</i> .....	38
	<i>Scanner default settings</i> .....	38
	Scanning barcodes.....	44
<b>4</b>	<b>Keyboard and Input.....</b>	<b>45</b>
	Keyboard Layout .....	45
	Special character input.....	46
	Using Input Mode .....	47
<b>5</b>	<b>Configuring Handheld Computer.....</b>	<b>48</b>
	Handheld Computer configurations.....	49
	<i>Setting launch applications</i> .....	49
	<i>Structure of the Application Settings</i> .....	49
	Network communication .....	53
	<i>Connecting to Wi-Fi networks</i> .....	53
	<i>Connecting to a virtual private network</i> .....	56
	Wireless Security.....	57
	<i>Certificates</i> .....	57
	Bluetooth communication .....	59
	<i>Pairing with a Bluetooth-enabled device</i> .....	59
	<i>Configuring Bluetooth settings</i> .....	61
	<i>Renaming or disconnecting a paired device</i> .....	61
	Communication via serial port and USB .....	61
<b>6</b>	<b>Management and Maintenance .....</b>	<b>62</b>
	Upgrading system software .....	63
	<i>Upgrading AutoInstall application</i> .....	63
	<i>Manually upgrading Recovery Menu</i> .....	63
	Restarting the Handheld Computer.....	64
	<i>Restarting the system</i> .....	64
	<i>Restart factory settings</i> .....	65
<b>7</b>	<b>Specifications .....</b>	<b>66</b>
	Physical and Environment Specifications .....	66

# Technical Support

If you need installation or troubleshooting help, please contact us via:

Knowledge base: [www.hsmknowledgebase.com](http://www.hsmknowledgebase.com)

Honeywell knowledge base provides thousands of turnkey solutions. If the knowledge base can't help you solve your problems, you can submit your questions or ask question on Honeywell technical support website.

Technical support website: [www.hsmsupportportal.com](http://www.hsmsupportportal.com)

Login Honeywell technical support website to search for knowledge base, submit your difficulties or questions, ask for call-back services or provide feedbacks. Please provide more detailed information when filling the forms. You can also upload attachments for explanation.

Contacts: [www.honeywellaidc.com/locations](http://www.honeywellaidc.com/locations)

For the latest contacts, please visit our website.

## Product Service and Maintenance

Honeywell International Inc. provides services for all of its products all over the world via its service centers. For information about the site of service centers, please visit [www.honeywellaidc.com](http://www.honeywellaidc.com) and select English as preferred language, then select **Support > Contact Support > Service and Maintenance**. Please contact our service center to get RMA (Return Material Authorization) numbers before sending the products for maintenance.

To get Honeywell service during warranty or out of warranty, please send the product together with the purchase date records to Honeywell service center (postage paid).

## Limited Warranty

For information about the warranty, please visit [www.honeywellaidc.com](http://www.honeywellaidc.com) and select Chinese (中文) as preferred language; tap **Resources > Warranty**.

## Feedback

Your feedback is very important for us to improve the quality of documentation. Please contact Technical Communication Departments

to submit your feedback on the User Guide:  
[ACSHSMTechnicalCommunications@honeywell.com](mailto:ACSHSMTechnicalCommunications@honeywell.com).

# **1 Product Features of ScanPal EDA60K-0 Handheld Computer**

This chapter introduces the ScanPal EDA60K-0 handheld computer with Android 7.1 OS, hereinafter abb. EDA60K-0 or handheld computer. User may acknowledge the basic features, functions and other information about accessories from this chapter.

# About EDA60K-0 Handheld Computer

Honeywell's ScanPal series handheld computers are smart terminals primarily targeted at enterprise users. It provides, through its Android OS, stable and secure enterprise data management and wireless communication. The main features of EDA60K-0 are: large storage capacity, high-capacity battery, stable scanning function and extreme robustness.

- Android™ 7.1 OS.
- 2 GB dynamic RAM, 16GB flash memory.
- Sensitive 5-point capacitive touch screen, WVGA display
- High-performance scanner<sup>1</sup>.
- IEEE 802.11a/b/g/n/ac.
- Bluetooth 4.1.
- High value-added software components support professional imaging and optical character recognition (OCR) features<sup>2</sup>.
- Multiple 1.5m drops to concrete ground at normal temperature; 1,000 tumbles within 0.5m
- IP64 Ingress Protection.
- Reliable Micro SD slot that supports up to 32GB.

*Note 1 2: EDA60K-0 has N4313 and N5603 versions with different OCR functions due to different configurations.*



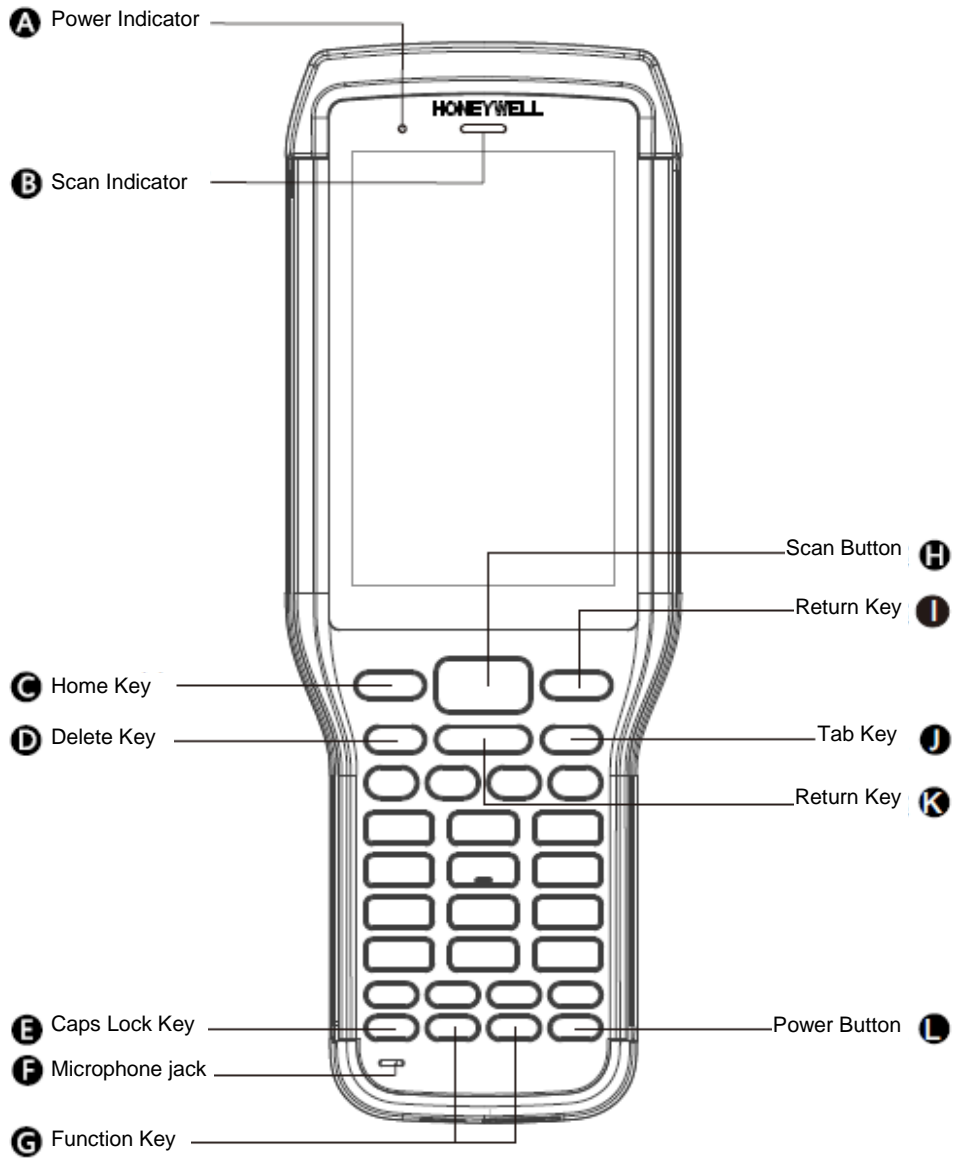

EDA60K-0 front view

**Left Side View**



**Right Side View**

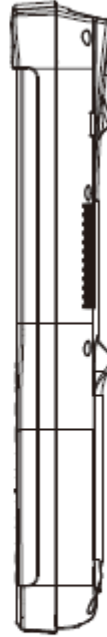

**The Bottom**



**A** Charging contact

USB cover **B**

EDA60K-0 side and bottom views

## Rear board

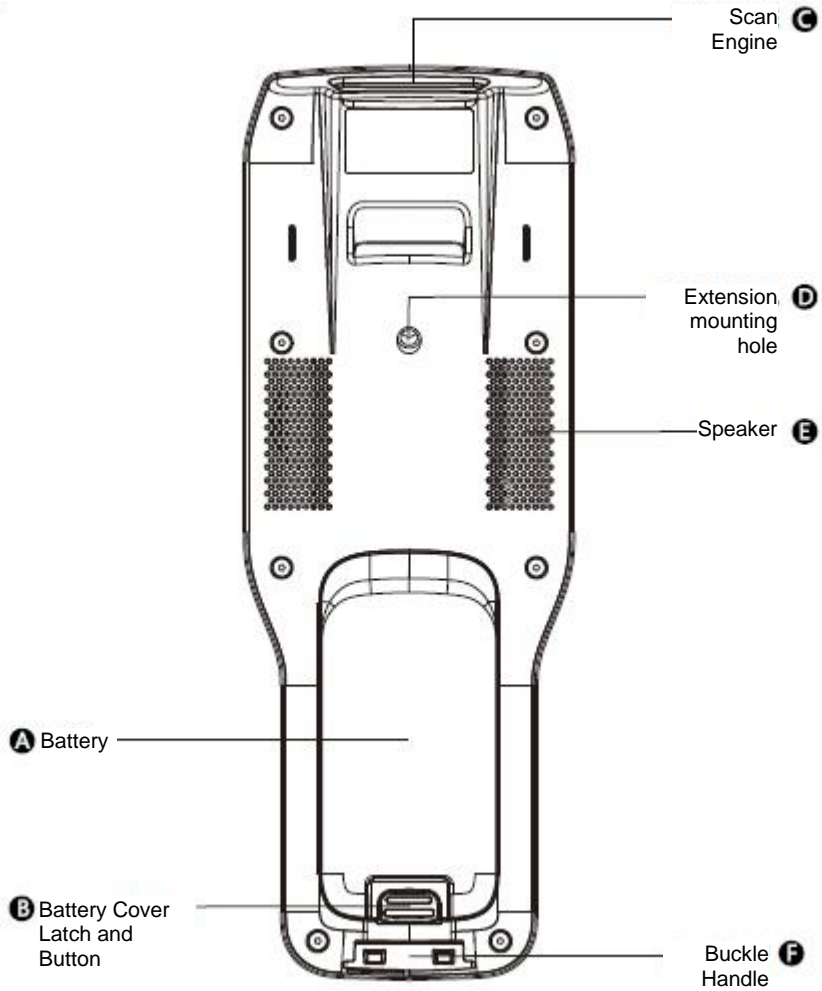

EDA60K-0 rear view

# Battery

EDA60K-0 uses 3.7V rechargeable lithium ion battery as its main power supply. The battery capacity is 18.9 watt/hour. Battery life is influenced by many factors, such as: screen brightness, the length of time before the screen automatically go to sleep, input configurations, extreme temperature and using behaviors, etc.

Honeywell suggests you to keep the battery charged to avoid data loss. Change battery only after switching off the device as per normal. Switch on the device after completing change of battery.

If you need to buy a replaceable battery, please contact regional resellers.



**Warning: Improper use of the battery of this device can cause a fire or chemical burns. Please don't disassemble the battery or heat it to 100 ° C (212 ° F) and above, or incinerate the battery. Make sure waste batteries are properly disposed. Keep out of reach of the children.**

**We would recommend using only Honeywell's lithium battery; any damage caused by use of non-Honeywell battery is not covered by warranty.**

## Charging

Before using EDA60K-0, you need to make sure the battery (model number AB18) is fully charged. You can charge the battery before or after installing it to EDA60K-0. It will take about 5 hours for the battery to be fully charged using original quad charger (cradle charger or otherwise).

**We would recommend using Honeywell's original charger; any damage caused by use of non-Honeywell charger is not covered by warranty.**

## Replacing batteries

When the battery power is low, you can charge it together with the Handheld Computer, or replace it with a fully-charged battery.

1. Save all the files and close all running Apps.
2. Long press the **Power** key. Until the follow interface pop up:

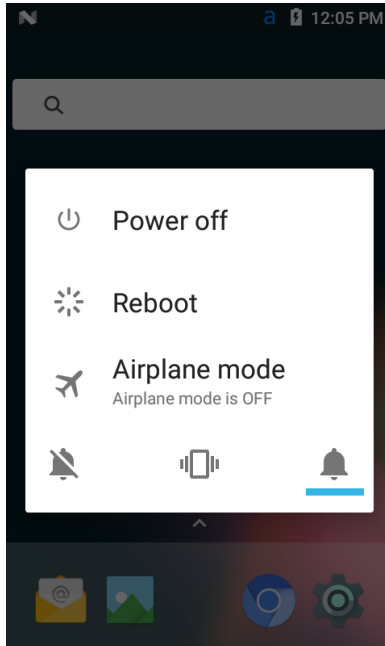

3. Tap **Power Off**.
4. EDA60K-0 will ask whether to power off, tap **Yes**.

After it's turned off, do as the following instructions manually:

1. Press the battery cover latch and button in the arrowhead direction to unlock it;

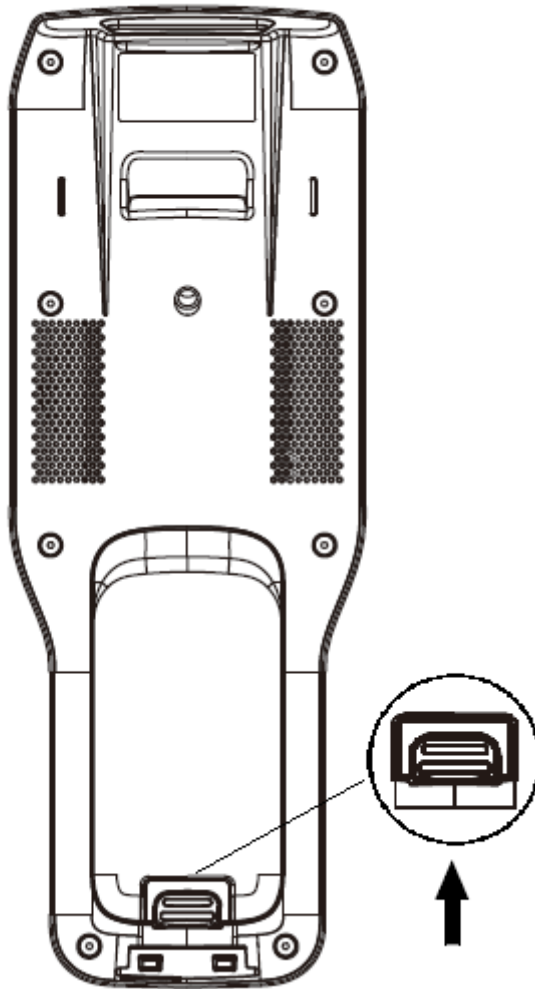

2. Flip the battery out in the arrowhead direction;

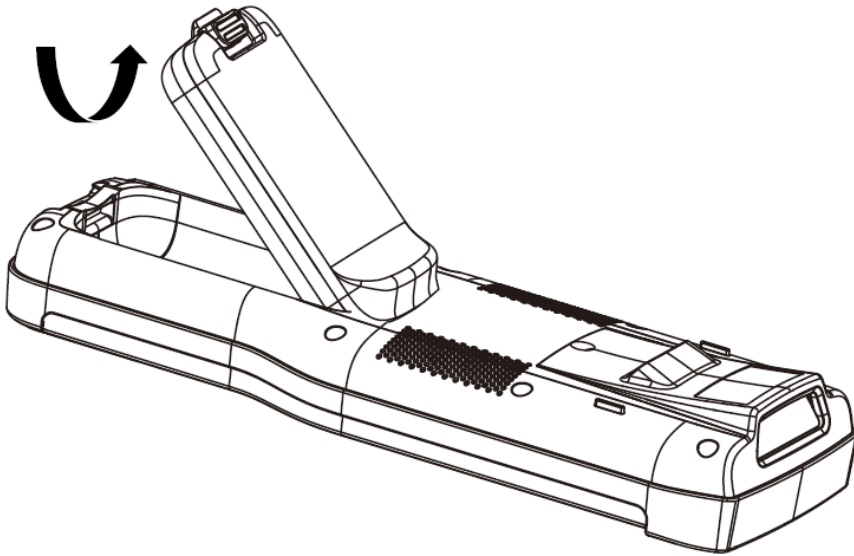

3. Put one end of battery onto limit slot, and flip in the battery in the arrowhead direction;

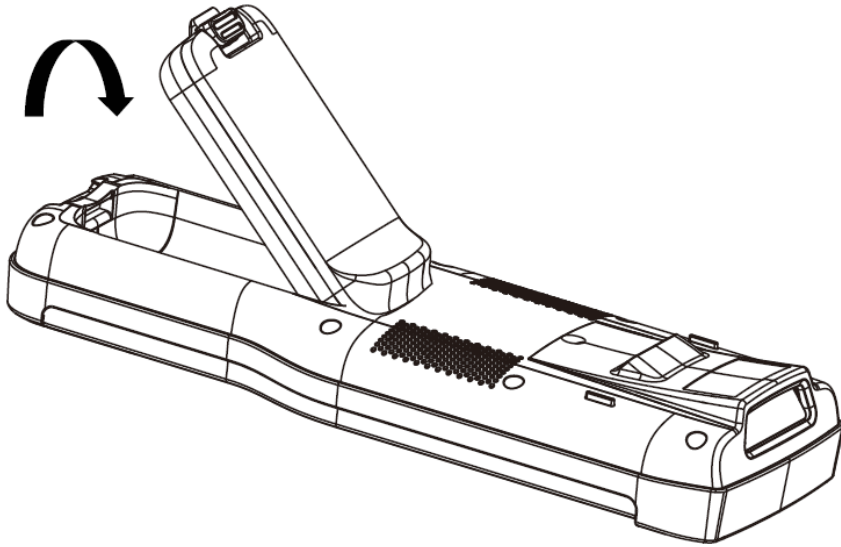

4. Press the back of battery in the arrowhead direction, till the mechanism of battery-cover latch is locked; then the batter is installed.



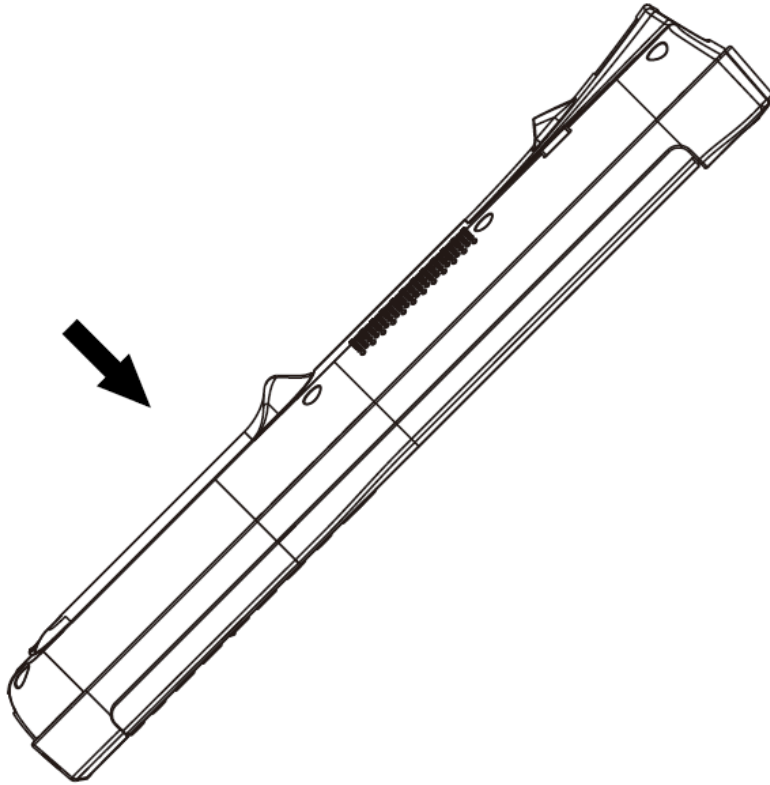





## Battery icon

Battery icon on the status bar shows the power status of the battery. The following table only contains several of the icons. For detailed information about battery life and power remained, please go to **Settings > Battery**.

### Battery icon

Icon	Status
	Battery power is 100% full
	Battery power is 50% full
	Battery power is too low. Replacing the battery right now.
	The handheld computer has been connected to external power supply for charging.
	Batter failure occurs. Please replace the battery. If the failure still exists, please contact Honeywell technical support.

Power indicator on the upper left corner of the Handheld Computer shows the battery charging status. It can also be used as system message indicator. For detailed setting methods, please refer to <http://developer.android.com/guide/topics/ui/notifiers/notifications.html>.

### Default power indicator description

Connect to power supply	Indicator status	Description
No	Flashing amber (orange)	Battery power is less than 15%
No	No light	Battery power is higher than 15%
Yes	Stable amber (orange)	Battery power is between 0% to 60% full
Yes	Flashing green	Battery power is between 60% and 95% full
Yes	Stable green	Battery power is higher than 95% full
Yes/No	Flashing red	Battery failure

## Changing power indicators

If the default indicators for battery charging (flashing green) is inappropriate for your environment, you can change the indicator.

In addition to changing the default power indicator, you can also select:

- Default Battery LED
- No Battery LED

If you prefer the indicator to be solid amber and to change to solid green when in charging, you need to perform **Default Battery LED** settings. If you prefer the indicator as message notification (application or device management solution notification) indicator, you need to select **No Battery LED** settings.

### Default power indicator meanings

Connect to power supply	Indicator status	Description
No	Flashing red	Battery power is less than 15% full
No	No light	Battery power is 15% or more
Yes	Stable red	Battery power is less than 15% full
Yes	Stable amber	Battery power is between 15% to 90% full
Yes	Stable green	Battery power is over 90% full

1. Tap **All Applications > Settings > Honeywell BatteryLED**
2. Select from the following options:
  - Default Battery LED
  - HSM Battery LED (Factory settings)
  - No Battery LED

## Checking the remaining battery capacity

Except for the battery icon and power indicator, you can also get the battery capacity information from Settings.

1. Tap **All Applications > Settings**.
2. Tap **Battery**. The current percentage of remaining battery capacity and the remaining time will be displayed. The list will present the power consumed by each application and service. For detailed usage information, please tap the respective applications and services in the list.

## Battery life and maintenance

The battery will discharge slowly if it's placed outside of the Handheld Computer. Honeywell Technical Support advises you to store battery in recharger to maintain battery performance.

### Tips for battery maintenance

If you have the following needs:	Power saving plan:
Low power icon shows on the screen or the power indicator lights on when the Handheld Computer is in use	Long press the Power key and choose <b>Turn Off</b> . After the Handheld Computer is tuned off, take out battery and replace with a fully charged battery.
The Handheld Computer will not be in use for 5 mins or more	Make sure no low power icon displayed and the power indicators doesn't light on. Switch to sleep mode by pressing the <b>Power key</b> .
The Handheld Computer will be stored for more than one day	<ul style="list-style-type: none"><li>• If you need to store this Handheld Computer for several days (like a weekend), you need to install a fully charged battery or connect the Handheld Computer to the power supply.</li><li>• If you need to store it for a longer time, remove the battery and charge it. Put the Handheld Computer and the battery in a shady and cool place after the battery is fully charged.</li><li>• If the battery is to be stored for several months, regular charging is needed for excellent battery performance.</li></ul>

---

Store the battery outside  
the Handheld Computer

Put the battery in the charger.

---

-

## Battery maintenance recommendations and safety protection measures

- Fully charge the battery before using it. The battery is only partly charged when get packed.
- Refer to the chapter "charging" to get the right process for battery charging. Using the battery for other devices may cause damages on the device or the battery.
- Avoid battery or Handheld Computer drops. If you suspect that a battery or Handheld Computer fails, send it to Honeywell service center for verification.
- This battery can only replace another AB18 battery. These batteries have been tested and meet the appropriate safety standards. If you need to replace the battery, please contact Honeywell service representatives or the resellers.
- There are security risks in waste batteries. Before cleaning up the battery, stick the poles with insulation tape.
- Do not modify the battery or attempt to insert foreign objects into the battery.
- Do not solder directly to the battery poles.
- Do not short connect the battery and put the battery away from metal objects.
- Do not drop or mechanically shock or extrude the battery.
- Do not disassemble or open the battery. Do not crush, bend or deform the battery; Do not puncture, shred or burn the battery.
- Do not immerse the battery in water.

## Enabling Airplane Mode

If you don't need to connect to any wireless network, you can enable the airplane mode to turn off all wireless receivers to save power.

1. Tap **Settings**.
2. Tap **More** under **Wireless & Networks**.
3. Select **Airplane Mode** box to enable airplane mode.

# Power on

After the battery is fully charged and installed EDA60K-0, turn on it for the first time:

Press down and then release the **Power key**.



**Please note:** after the installation instructions are completed, the welcome interface will not appear again. The interface appears as locked screen interface after each time you turn on the Handheld Computer.

# Unlocking the screen

Every time you turn on the Handheld Computer EDA60K-0, you need to unlock the screen.

- Slide the lock icon to any edge of the screen to unlock it.

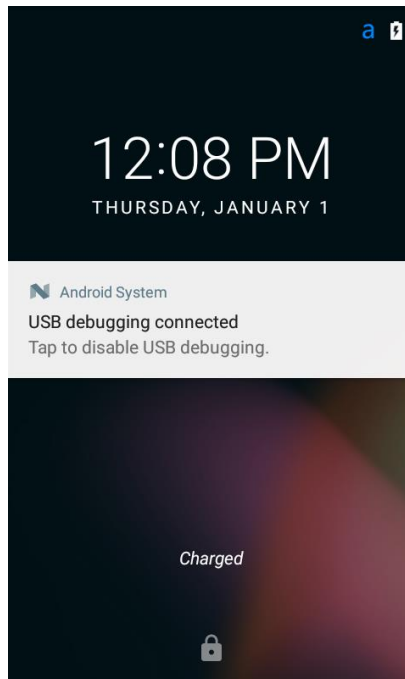

- After the EDA60K-0 is deployed, we suggest you to set password to protect your Handheld Computer. Tap **All Applications > Settings > Security > Encryption**.

# Scanning Indicator

The scanning indicator indicates the status of the scanner. For barcode scanning method, please refer to the chapter "Scanning barcodes".

## Scanning indicator definition

Light of the indicator	Meanings
Green	Good read for the barcodes
Red	Barcodes reading failed

# Backlight for Setting Screen

You can opt to set the backlight according to the needs of environment.

1. Tap **Settings**.
2. Press **Display > Brightness**.
3. Slide bar to adjust backlight brightness.

# Backlight for Setting Button

To save battery power, the button's backlight will be deactivated as default; the user can opt to switch on button's backlight, that is, press the button when the system is running, and the backlight will be on, so as to save battery power.

1. Tap **Settings**.
2. Press **Display>Button Backlight**.
3. **Activate** or **Deactivate** button backlight

## Audio features

EDA60K-0 is equipped with speaker and software utilities for volume setting.

### Adjusting the ringtone volume for calls and messages

With the volume key on the side of the Handheld Computer, you can quickly adjust the ringtone volume.



**Note:** Volume key can only adjust ringtone volume for calls and messages. To adjust volumes of other sound, open **Settings**, and tap **Sound > Volumes**.



1. Press the blue key at the bottom of Handheld Computer, and 'a' will appear in upper-right corner of the screen.

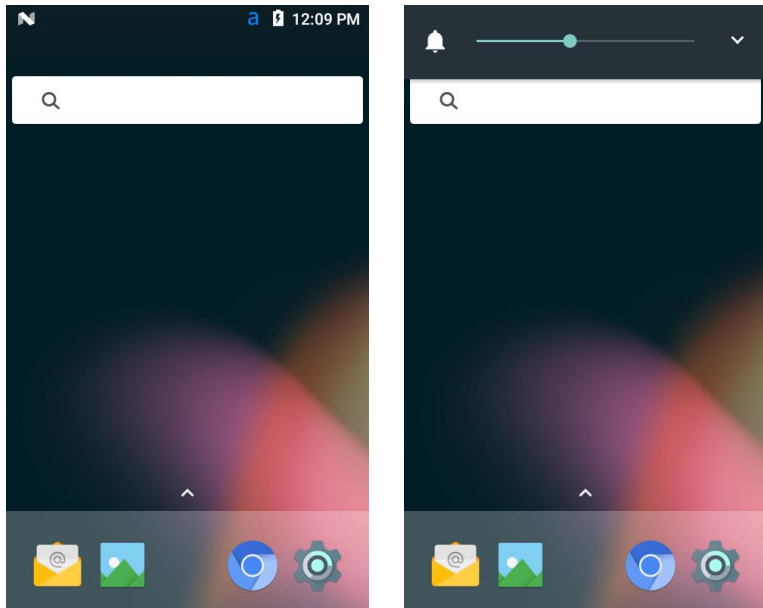



2. Adjust the volume by pressing volume key or slide volume bar. Hold down the volume button or pull the volume indicator to the extreme left to activate vibration mode.

## Enabling vibration mode

You can set the Handheld Computer to vibration/silence mode in the office. There are two ways to do so.

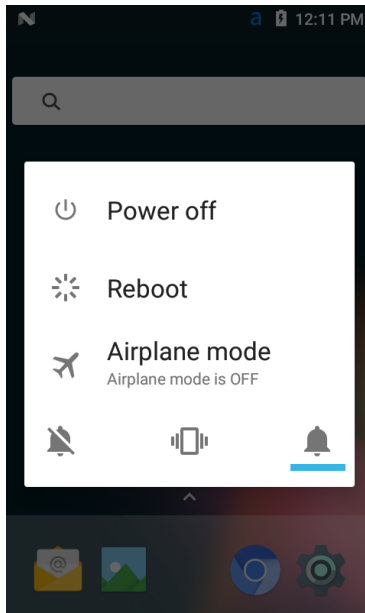
1. Long press the **Power Key**. Power options will be displayed on the screen:



2. Tap  to enable vibration mode.

\* For the other way please see [Adjusting Ring and Message Volume](#)

## Audio settings

This chapter will describe about audio and sound settings. To change audio setting, go to **Settings** and tap Sound.

### Audio and sound settings

Settings	Description
Volume	Use the volume adjustment bar to set the volume for: Music, videos, games and other medias. Ringtones for calls and message notifications. They can also be adjusted by the volume key on the side of the phone. Alarm and alert tones
Default notification tone	Select one of the notification tones
Default alarm ringtone	Select one of the alarm ringtones
Charging tone	If checked, the charging tone will be enabled
Lock-screen tone	If checked, lock-screen tone will be enabled

# Inserting SD card

You can use a SD card to expand the memory or to install softwares. Honeywell recommend the using of Single Level Cell (SLC) graded SD memory card or SDHC memory card in order to achieve optimum performance and durability.



**Note:** format the memory card when you use it for the first time.

1. Turn off the Handheld Computer;
2. Press battery cover latch and button; pull out the battery;
3. Push card sleeve in the arrowhead direction to unlock, and then open card sleeve upward;
4. Insert Micro SD card onto slot;
5. Put back the card sleeve, and push card sleeve in the arrowhead direction to lock;
6. Put in battery, and gently press the battery back, till the cover latch is securely locked;
7. Switch on the device.

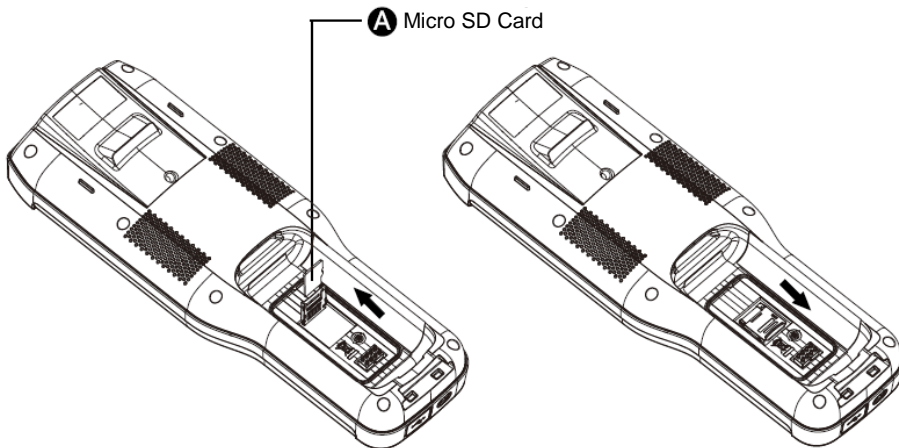

# Fire transfer

Files can be transferred between the Handheld Computer and a computer by using a USB adapter or standard USB cable. By connecting the Handheld Computer to a computer with a USB cable, you can view the files in the Handheld Computer, or transfer the files to the computer, or transfer files from the computer to the Handheld Computer. If you transfer files with a Mac computer, you need to use Android File Transfer app (it can be download via [www.android.com/filetransfer](http://www.android.com/filetransfer))

The Handheld Computer will use MTP (Media Transfer Protocol) connection as default. If you mainly transfer camera photos, you can use PTP (Picture Transfer Protocol) connection settings. If the computer with Windows system doesn't support MTP, you can use PTP transmission.



**Note:** EDA60K-0 supports high-speed USB communication (USB2.0), with maximum data transfer rate at 480 Mbps.

1. Connect EDA60K-0 to the computer.
2. Select Media device (MTP) or Camera (PTP) on the EDA60K-0 screen.
3. View the files stored in EDA60K-0. You can copy, delete or transfer the files between EDA60K-X and the computer.

# How to view files on EDA60K-0

Users can view the files in EDA60K-0 and its memory card through File Explorer.



**Note:** Due to system permission issues, some files cannot be opened. Based on your needs, you can select respective apps to open the file.



1. Tap **Applications > File Explorer** 文件管理器.
2. Tap the folder name or file name to open the file.

# EDA60K-0 Accessories

EDA60K-0 Handheld Computer is equipped with original battery and wall charger. All other accessories require separate order and shipment. If necessary, please contact your local sales representatives.

## EDA60K-0 Accessories and Description

Accessories	Description
EDA60K-0 Battery (AB18)	The battery is capable of providing several hours of charge to EDA60K-0. Spare battery packs can be ordered to extend the service time.
Wall charger	For charging of EDA60K-0 terminal.
Home Base	Charge EDA60K-0 and its attached battery simultaneously with the Hme Base, or charge the battery independently.
Quad Battery Charger	Use Quad Battery Charger to charge up to four pieces of AB18.
Wristband	Wristband makes it convenient to carry or take the device.
Scan Gun Handle	Scan gun handle provides convenient and flexible scanning function, and is easy to load and pick.

# **2 User Interface and Application**

This chapter introduces the Android system user interface, and how to interact with the screen. Users can also learn about a variety of Honeywell applications on the Handheld Computer through this chapter.

# User interface

Android 4.4 operating system user interface provides users with a perfect touch and easy navigation experience.

## The main interface

After turning on the Handheld Computer and setting up your preferred language, the main interface will be displayed on the screen first.

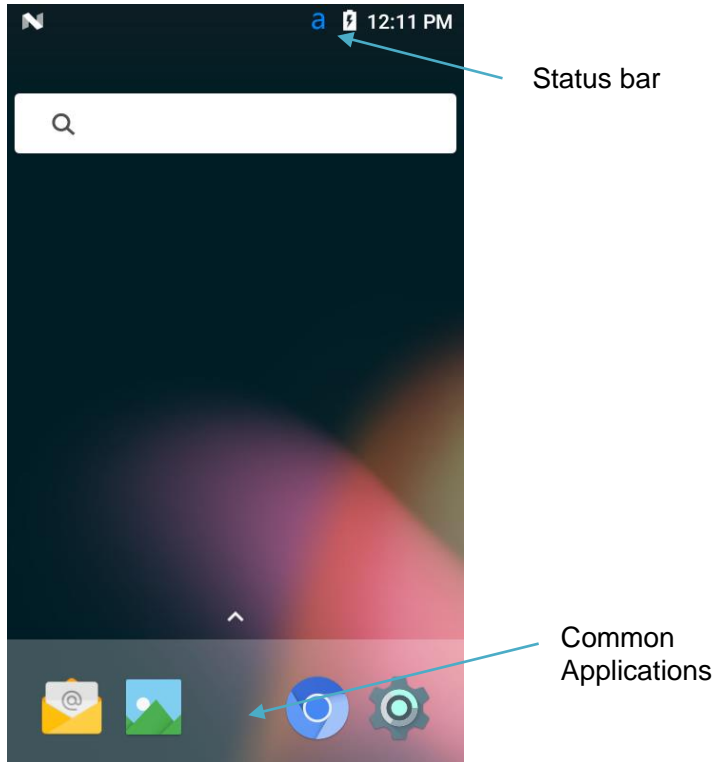

## The main interface description























Name	Description
Status bar	The left side of the status bar displays system messages sent by the application, such as information notifications. The right of the status bar displays the current wireless and network connection status and remaining battery power.
Common applications	The applications on this bar will be displayed on the main interface. <b>All Applications</b> option is in the middle of the common application bar.

## Status bar icons

Status and notification icons display the current network connections, power, notifications and sound settings. Please refer the following table for detailed status bar icons:

### Status and notification icons:

Icons	Description	Icons	Description
	Incomplete calendar events		Sound is disabled
	Not ringing alarm clock; alarm clock set		Vibration mode has been enabled
	New text message or multimedia information		Battery power is 100% full
	Text messages or multimedia information transmission failed		Being in charge with external power supply
	New mails		Airplane mode is enabled
	The Handheld Computer is connected to the computer via USB cable		EDA60K-0 is syncing with Bluetooth-enabled device
	ABD has been enabled (USB troubleshooting has been enabled)		Bluetooth has been enabled
	Data Sync		Wi-Fi signal is adequate
	Sync or account logon failed		Wi-Fi is connected, but with no signal
	Memory card is full		Network connected

## Key mapping

The user can change left and right scanning buttons, as well as P1, PS default functions.

1. Tap **All Applications > Settings > Key Remap**.
2. Touch the keys you want to redefine.
3. Tap **KEYS** or **APPs** to view options.
4. Select the required functions for the key. The new functions selected will be displayed under the name of the key.

## Viewing system messages

Users can view EDA60K-0's system messages in the notification page.

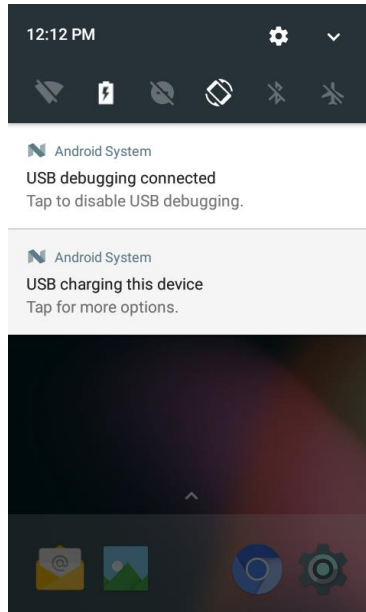

- Open the notification page: swipe down from the top of the screen.
- Close the notification page: swipe up from the bottom of the screen or tap **Return** key or **Home** key.

## Managing system messages

When the applications send system messages to EDA60-K, users can manage them quickly.

1. When the system message icon appears, swipe down the screen.
2. To manage the system message, touch it. The respective application will be opened for users to manage it.
  - Swipe the system message to the side to clear it.
  - Tap the icon on the top right  of the screen to clear all system messages.

## Personalizing the main interface

You can add application icons to either one of the main interface to open these applications more quickly.

1. Tap  to display **all applications**.
2. To move the application icon to the main interface: long press the icons to be added to the main interface, then slide your finger to place it on either one of the main interface.  
To move the widget icon to the main interface: touch the widget on the top of the screen, long press the widget icon, then slide your finger to place the control icon on either one of the main interface.
3. To remove the applications or widgets from the main interface: long press the icons and slide to **X Delete** on the top of the interface.

## Customizing common applications

User can add applications to the common application bar to open these applications more quickly.

1. Tap  to display **all applications**.
2. Long press the icons in the common application bar and slide it to the **X Delete** on the top of the interface.
3. To add application icon to the common application bar: long press the application to be added, and slide your finger to place the icon on the common application bar.  
To add the widget to the common application bar: touch the widget on the top of All Application Interface, long press the widget icon to be added, then slide your finger to place the icon on the common application bar.

## Touch screen gestures

User your finger can operate applications, menus, on-screen keyboard and other functions on the interface.

- Tap a function or application to select or start it.
- To enter a name or password, touch the place to enter and on-screen keyboard will appear for input.

Other touch screen gestures include:

- Long press: press an icon and hold until the system reacts.
- Drag: Press an icon, and then move your finger across the screen to the destination. For example, with dragging method, you can rearrange some shortcuts on the main interface.
- Swipe or slide: Quickly move your finger on the screen and keep your finger touching on the screen. For example, users can swipe the home screen to the left or right to view other home screens.
- Double-click: Tap twice rapidly in a row on the map or other interface to enlarge it. Double-click again to return to the original size.
- Kneading: In some applications, subjects can be zoomed out by kneading two fingers on the screen, or zooming in by expanding two fingers.

## Setting timezones

EDA60K-0 can automatically sync the time and date according to the network. Users can also set timezones for their regions manually.











1. Open **Settings**.
2. Tap **Date & Time**.
3. Uncheck **timezone automation**.
4. Tap **Selecting Timezones** and tap the timezone for your region.

# Honeywell applications

Honeywell helps users troubleshoot and connect the Handheld

Computer to other devices and networks. Tap  **All Applications** > Power Tools to show the applications below. For more details, please visit [www.honeywellaidc.com](http://www.honeywellaidc.com).

**EDA60K-0 software applications available, including but not limited to the following functions**

Icons	Applications	Descriptions
	Demo	Demo and more included, allows testing and using functions like scanning.
	ConfigApps	Prohibit/use and uninstallation of applications
	Configure Autorun	Autorun application when the device is being activated
	Backup	Backup and restore user data and settings
	BattMon	Monitors battery-charging status
	Diagnostic Information	Check equipment information, Honeywell applications, radio frequency information, RAM and scanner
	EZConfig	Configure equipment and applications through barcode and configuration documents
	EZConfig Editor	Check and edit configuration documents and update settings
	Auto Install Settings	This application can automatically identify and install installation packages and APK files.
	Wi-Fi Radio Setting	This application is configured with Wi-Fi country code and communication channel, and can display signal intensity and configure Log.



## Download Enterprise Application Lock (Applock)

Applock is an Android application which allows you to configure the apps that may or may not be allowed. The User Guide and installation procedure for Applock may be downloaded via:

[www.honeywellaidc.com](http://www.honeywellaidc.com).

## Unlocking developer options

If you are a developer for EDA60K-0, you can easily unlock developer options. Developer options can help you test and troubleshoot during the process of developing EDA60K-0. After developer options is unlocked, the system menu will present developer option connections.

1. Tap **Settings**.
2. Tap **About the Phone**.
3. Click the Build number 7 times and notification as 'You are now in developer mode' will appear.



# **3 Scanning Function**

This chapter describes how to scan barcodes and set scan functions.

# Scan Function

Integrated scanner enables reading for 1D and 2D barcode<sup>1</sup>, composite code and postcode. It supports comprehensive, highly flexible scanning in real applications. Imaging Engine can capture black and white images, such as signatures and damaged inventory lists.

*Note 1: EDA60K-0 has N4313 and N5603 versions with different OCR functions due to different configurations.*

## How to transfer data via Android keyboard input

Scan wedge feature enables transferring scanned barcode data to active applications via Android keyboard input. Scan wedge function is enabled by default on EDA60K-0. Users can use applications that can accept scan wedge function through scanners or applications. If an application obtains scan function through Barcode Reader API, the scan wedge function will be temporarily disabled.

Users can build customized applications in Software Development Kit (SDK) for ScanPal EDA60K-0. Please download SDK at: [www.honeywellaidc.com](http://www.honeywellaidc.com).

### Processing and settings for scanned data

Processing steps	Respective scan settings	
Decode barcodes	Symbology settings	
Parsing the barcode as ISO8859-1	Symbology settings	
Special barcodes detected activate special actions, rather than performing the normal operations.	Data processing settings	Start your browser Scan to Internet EZConfig enabled
Converted to the selected character set	Data settings	Character set

---

Add a prefix and suffix to make the data string in the following order:

- Prefix Prefix
- Sign prefix Data processing settings Sign prefix
- Barcode data Suffix
- Suffix

Parsing the replacement for prefix and suffix string

---

Activate Total Freedom plug-in	Data processing settings	Data editing plugin
--------------------------------	--------------------------	---------------------

---

Input the final data as Android Key Events	Data processing settings	wedge
--	--------------------------	-------

---

Prefix and suffix will be replaced within the string value.

### Prefix and suffix parsing

Substring	Replacement character code	Wedge in form of KeyEvent
\r	13	No
\n	10	Yes
\t	9	Yes
\\	'\'	No

---

## Changing scan settings

Changes made the default file apply for all non-document applications.

1. Tap **Settings**.
2. Tap **Scanning**.
3. Tap **Default**.
4. Select Data Processing Settings, Symbology Settings, Decode Settings, Imager Settings, Trigger Settings or Notification Settings.
5. Modify the setting to meet application needs.

## Restoring default scan settings

Users can easily cancel all the changes made to the default folder and restore the factory defaults.



**Note:** Restore factory defaults for a certain setting, all the settings under this folder will be restored to factory defaults.

1. Tap the icon  on the upright of any Scan Settings interface.
2. Tap the **Restore all defaults**.

## Scanner default settings

Study the following table to learn about Data Processing Settings, Symbology Settings, Decode Settings, Imager Settings, and Trigger Settings and Notification Settings.

### Data processing settings

Use data processing settings to set the barcode data processing patterns for EDA60K-0.

#### Data processing settings

Settings	Description	Default
Wedge	Enable or disable the transferring of barcode data as Android Events when sending data to the application.	Enabled
Character set	<p>Explain the selected character set when the barcode is a character, options including:</p> <ul style="list-style-type: none"><li>• ISO-8859-1</li><li>• US-ASCII</li><li>• UTF-16</li><li>• UTF-16BE</li><li>• UTF-16LE</li><li>• UTF-8</li></ul> <p>The related BarCodeReader attributes: PROPERTY_DATA_PROCESSOR_CHARSET</p>	ISO-8859-1

Prefix	Define the character to be added in front of the decoding barcodes	No
Suffix	Define the character to be added at the end of the decoding barcodes	No
Data editing plugin	Specify a free plug-in for data editing	No
Character prefix	Specify a character prefix to decode the barcode data <ul style="list-style-type: none"> <li>• None</li> <li>• Honeywell</li> <li>• AIM</li> </ul>	No
Start your browser	To open or close URL barcode, if the barcode start with http:// or https://, the browser will open the respective URL The related BarCodeReader attributes: PROPERTY_DATA_PROCESSOR_LAUNCH-BROWSER	Enabled
Scan Intent	Enable or disable scan processing for specified targets. Apply the barcode as the following format ‘//’ ACTION ‘//’ intent-suffix ‘\$’ extra-data Where: Additional operations and data include the following characters, to enable Intent or respective applications Intent action: “com.honeywell.scantointent.intent.action.” + ACTION Intent extra “com.honeywell.scantointent.intent.extra.DATA” contains the remainder of the bar code data after the first ‘\$’ character. The related BarCodeReader attributes: PROPERTY_DATA_PROCESSOR_SCAN_TO_INTENT	Enabled

---

	Enable or disable specifying EZ Config operations to barcode. Adopt Aztec code and include specified header data.	Enabled
Start EZ Config	The related BarCodeReader attributes: PROPERTY_DATA_PROCESSOR_LAUNCH_EZ_CONFIG	

---

## Symbology settings

Enable or disable a barcode symbology with Symbology Settings. Tap on a symbol to view and modify the configuration parameters of the symbol.

### Symbology settings

Settings	Default
Code 128	Enabled
GS1-128	Enabled
Code 39	Enabled
Datamatrix	Enabled
UPC-A	Enabled
UPC-E	Disabled
EAN-8	Disabled
EAN-13	Enabled
Aztec	Enabled
China Post	Disabled
Codabar	Enabled
Codablock A	Disabled

Codablock F	Disabled
Code 11	Disabled
Code 93	Disabled
Composite	Disabled
Han Xin	Disabled
IATA 2 of 5	Disabled
Interleaved 2 of 5	Enabled
Korean Post	Disabled
Matrix 2 of 5	Disabled
Maxicode	Disabled
Micro PDF 417	Disabled
MSI	Disabled
PDF 417	Disabled
QR Code	Disabled
RSS (GS1)	Disabled
Standard 2 of 5	Disabled
Telepen	Disabled
TLC 39	Disabled
Trioptic	Disabled
2D Postal Settings	Disabled
OCR	Disabled

## Image settings

There should be no need for users to change image color rendering. **Covering the recommended value** is disabled by default. Recommended image settings can be applied in many environments; only the users who have more in-depth understanding on the image can change the settings.

## Trigger settings

Trigger settings can set up the using patterns for scan key.

### Trigger settings

Settings	Description	Default
<b>Decoding timeout</b>	If the scan trigger is held down but decoding is not successfully performed, Scanning will automatically shut down after 20 seconds	<b>20</b>



## Notification settings

You can set up the responses during scanning process for EDA60K-0 in the notification settings.

### Notification settings

Settings	Description	Default
Good Read Notification	Enable or disable Good Read Notification. Notification includes green indicator, short beep and optional short vibration	Enabled
Bad Read Notification	Enable or disable Fail to Read notification. Notification includes red indicator, failure beep and optional short vibration	Disabled
Vibrate Enabled	Regardless of succeeding or failing to read, turn on or off the phone vibrations	Disabled

# Scanning barcodes

Scan engine will emit scanning beams for accurate barcode aiming. It will also support a full range of 360° scanning, which will make barcode scanning more convenient.



**Note:** Before scanning a barcode, you only need to enable the desired barcode symbology in the settings.

1. Tap **Applications >Demos>ScanDemo**.
2. Align the scanning window with the barcode and stably place the Handheld Computer a few inches away from the barcode.
3. Press one of the scan keys or tap **Scan** on the interface. Make sure the entire barcode is within the scanning beam range.

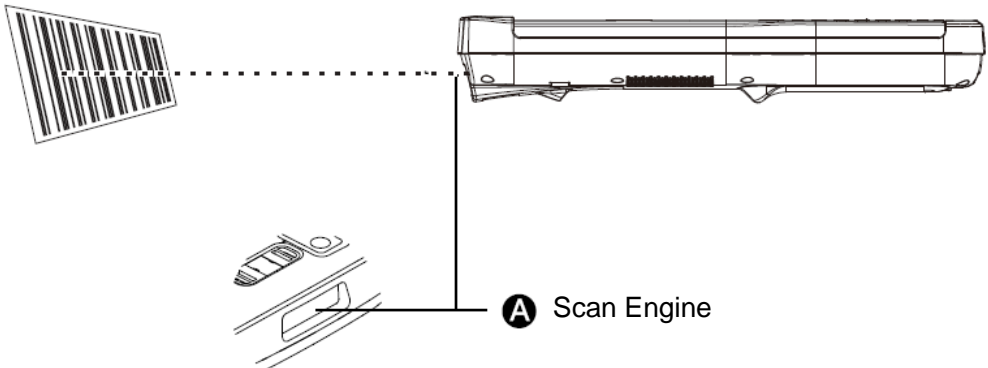

When the scanning is successfully completed, you will hear a 'beep' sound, and the Good Read LED will open immediately.

# 4 Keyboard and Input

This Chapter deals with keyboard layout of EDA60K-0, the respective functional keyboards and input application. A user can input text, numerals and special characters using the keyboard.

## Keyboard Layout

In addition to side button, EDA60K-0 is also equipped with 30-letter keyboard at the bottom of its screen. They are power, direction, scan, numeric/alphabet and function buttons.

Function	Description
Power ON	Hold down to activate or deactivate the device; press to lock and unlock
Scan	This offers scan function; users can also press it to unlock the screen
Direction	This button enables the cursor to be moved in four directions: up, down, left and right
PrintScreen Function	Press Power On and Direction keys simultaneously (Volume key -)
Numerals/alphabets	Switching between numerals and alphabets can be made using the blue button

aA	Shift/Caps button. When the Numerals/Alphabet button is in numerals mode, pressing the button will enable it to enter Shift function under which 'symbols' can be entered. When it is in alphabet mode, pressing it once will allow alphabets to be entered in capital letters; press it once again to switch to normal letters
ENT	Press this to confirm
DEL	Press this to delete individual character
Tab	Press this to switch menu
P1, P2, P3, P4	Soft key allows revision of mapping function. Under default status for mapping press P1 to switch WIFI settings, press P2 to switching Bluetooth settings, press P3 to decrease screen brightness and press P4 to increase screen brightness
Switch Function Key	These are respectively buttons for switching numerals/alphabets and functions (Fn). The blue button is for alphabet output, while the red button corresponds to function output.

## Special character input

Under the numerals input mode, use blue button to switch to the special character input mode.

123456789-0. correspond to the special characters !@#\$%^&\*(\_)> respectively

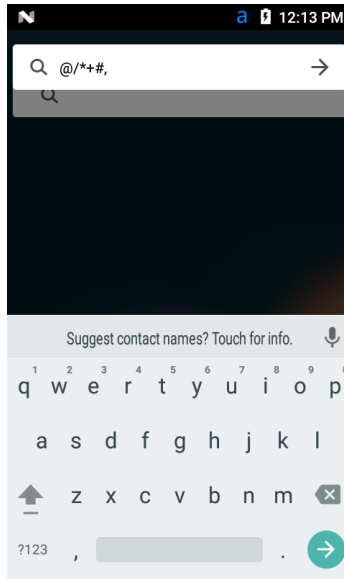

## Using Input Mode

EDA60K-0 supports its integrated input mode (Google AOSP) as well as third-party input mode (users have to make sure they have authority to install third-party input modes).

For input of Chinese and English characters, the '0' (spacing) button enables selection of characters.

Different input modes have different context for words entered. Please refer to the instructions for the respective input modes.

# **5**    **Configuring Handheld Computer**

This chapter introduces configuration of EDA60K-0. The users can also learn how to configure network, communication and wireless security.

# Handheld Computer configurations

Users can configure many parameters for the Handheld Computer, such as barcode symbologies to be decoded or network settings. These parameters set by the user decide how the Handheld Computer works.

Users can configure the Handheld Computer in Application Settings.

## Setting launch applications

Set the applications using the application menu.

Tap **Applications > Settings**

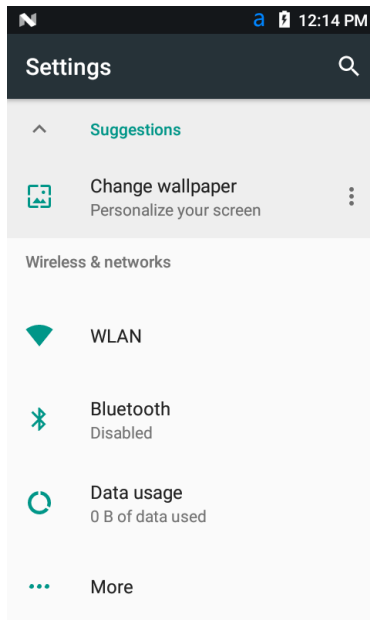

## Structure of the Application Settings

This chapter introduces the structure of Application Settings to make it easier for users to quickly locate respective specifications.

## Wireless & networks

Settings	Introductions
WLAN	To enable or disable Wi-Fi radios. When Wi-Fi is enabled, available Wi-Fi networks can be viewed by tapping this bar.
Bluetooth	To enable or disable Bluetooth radios. When Bluetooth connection is enabled, Bluetooth-enabled devices within the range can be viewed by tapping this bar.
More...	Airplane mode: to enable or disable Airplane Mode. VPN: to set the password for accessing virtual private network (VPN).

## Device

Settings	Introductions
Sound	Set sound for calls and notifications, including the tone and volume.
Display	Set screen brightness, wallpaper, screen timeout, font size and screen rotation.
Memory	Shows the remaining memory space.
Battery	Shows battery usage data and the current battery status.
Applications	Shows applications downloaded and on the run.

## Personalization

Settings	Introductions
Account	To set email account.
Security	To set screen lock and administration privileges, including application installation and data storage security.



---

Language and Input	Select the current language and the default keyboard. Set automatic input function, such as: capitalization and punctuation. Set the cursor speed for external mouse or touch screen.
--------------------	---

---

Backup and Reset	Factory Data Reset.
------------------	---------------------

---

## HONEYWELL Settings

Settings	Introductions
Key Remap	Redefines left scan button, right scan button, middle scan button and P1, P2 buttons. For more information please refer to Mapping Button.
Battery LED	Configuring battery LED lighting modes.
Scanning	Configure ScanPal EDA60K-0 imager. For more help, please refer to <i>changing scan settings</i> .
Log	Activates Android Logcat and Linux Kernel log services to facilitate identification of problems during the device's operation.
Smart sensor	Integrated sensor allows better power management.

## System

Settings	Introductions
Date and Time	Configure all the date and time settings.
Auxiliary functions	Set auxiliary function level, for example: large font and text-to-speech output.
Printing	Configure printing options.
About the phone	Shows information about the Handheld Computer.

# Network communication

Users can connect the Handheld Computer to wireless and wired networks. Users can get the Handheld Computer connected via the following ways:



- 802.11 radios
- Bluetooth
- USB

## Connecting to Wi-Fi networks

When communicating through wireless networks, ScanPal EDA60K-0 transfer data through 802.11 radios. Before connecting to a Wi-Fi network, users need to know the Security Protocol of the network and the certificates it required. Usually, 802.11 radio is disabled by default.

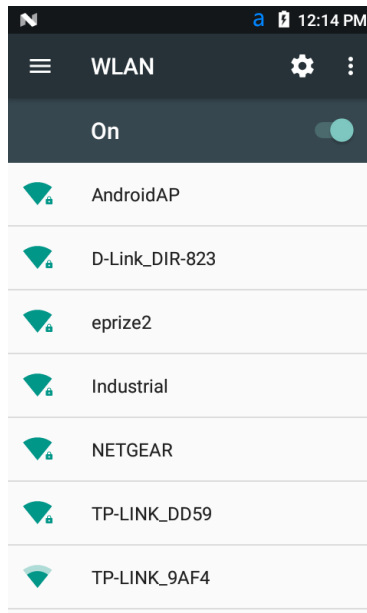
1. Enter **Settings**, slide the WLAN switch to enable it.
2. When the WLAN switch turns blue, tapping the WLAN bar will display the detected network list.



3. To quickly connect to a network via WLAN Protected Access (WPS), tap . To search the network outside of the list, tap  and enter the network name.
4. Tap on a network name to view its details.

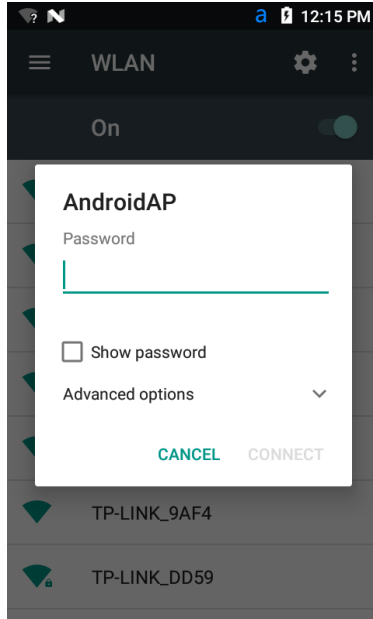

If the network is secure, a form will pop up asking you to fill in the necessary information (for example: certificate name, password or other credentials). To connect to a secure network, enter the required information, and then tap **Connect**.

- To leave the network that has been connected, tap **Forget**. For example, users can choose to forget a network that they won't use again.
- To close the network information screen, tap **Cancel**.

## Configuring Wi-Fi network proxy servers

If users need to connect to network resources through a proxy server, they need to configure a proxy server for each Wi-Fi network added. By default, none of the Wi-Fi networks added by users has done proxy server settings.



**Note: Proxy server settings only apply to the Wi-Fi networks that users modified. Users have to set proxy servers for each network that requires the using of proxy server.**

1. Enter Application Settings screen, tap Wi-Fi to show available Wi-Fi networks.
2. Long press the network name, then tap **Modify the Network**, then a network setting list will pop up.
3. Choose **Show Advanced Options** at the bottom of the network setting list.
4. If the network does not have proxy server settings, tap **None** on the proxy server setting list, and then tap **Manual** Settings.
5. Enter the network proxy server settings.
6. Tap **Save**.

## **Disable Wi-Fi notifications**

Wi-Fi is enabled by default. Users will receive notifications in the Status Bar when the Handheld Computer finds wireless networks. Users can disable these notifications.

1. Enter Application Settings screen.
2. Tap WLAN bar.
3. Tap the Settings icon on the bottom right.
4. Tap Advanced to display Wi-Fi **Advanced Menu**.
5. Uncheck the **network notification** to disable Wi-Fi Notifications.

## Connecting to a virtual private network

The Handheld Computer supports connection to virtual private networks (VPNs). This section describes how to add and connect to VPNs. To configure a VPN, users must consult your network administrator. Users can view and change VPN settings in the Application Settings.



**Note: Before accessing VPNs, users need to set a lock screen password.**

### Add VPNs

Before connecting to a VPN, users must first add the relevant information of the VPN.

1. Enter Application Settings screen.
2. Tap **More** under **Wireless and Networks**.
3. Tap VPN.
4. Tap Adding +.
5. Input the VPN information.
6. Tap **Save**, and VPN name will be displayed in the list.

### Connect to VPN

1. Enter Application Settings screen.
2. Tap **More** under **Wireless and Network**.
3. Tap VPN.
4. Tap the VPN name in the list, and enter the certificate information based on the tips.
5. Tap **Connect**. The Handheld Computer gets connected to the VPN, and the status icons and notification will be displayed. To disconnect from the VPN, tap the notification.

### Edit VPN information

1. Enter Application Settings screen.
2. Tap **More** under **Wireless and Network**.
3. Tap VPN.
4. Long press the name of the VPN to be edited and select **Editing Networks** from the list.

5. Edit VPN information based on your needs.
6. After editing, tap Save.

## Wireless Security

The Handheld Computer provides the following security solutions for users' wireless network.

- WPA2™
- WPA
- 802.1x
- WEP

Before setting up security program, you must first enable the radio and set the date and SSID on the Handheld Computer. To use 802.1x program, users must download a root certificate to the Handheld Computer. To use Transport Layer Security protocol (TLS) together with 802.1x , users also need to download a user certificate first.

View and configure all of the wireless security settings in the Application Settings screen.

## Certificates

Users can use digital certificates to identify the Handheld Computer's network access or server validation. To identify the device with certificates, users must first install the device to the trusted certification store on the Handheld Computer.

Android supports DER encoded X.509 certificate stored in the documents with .crt or .cer extension. Install a valid DER-format certificate. Android also supports X.509 certificate stored in PKCS # 12 key store file with p12 or .pfx extension. To install a valid key storage file with other extensions at the end, users must change the extension to .p12 or .pfx first. If users installed a certificate from the PKCS # 12 key store file, Android will also install the private key certificate or a certificate authority that came with it.

### Download certificates

To use the certificate, users must first install the certificate to the trusted certification store on the Handheld Computer.



**Note:** Some applications that support certificates, such as email and browsers, allow users to install the certificate directly from the

application. For more information, please refer to the Help Documentation in the application.

1. Copy the certificate or key storage from computer to the SD card.
2. Install the SD card in the Handheld Computer and turn on the Handheld Computer.
3. Enter Application Settings, tap **Safety > Install From SD Card**.
4. Tap the name of the certificate or key storage to install. Following the tips to enter the password of the key storage, then tap **OK**.
5. Enter the certificate name and tap **OK**.

## **Disable or delete certificates**

If the certificate is a stolen one or the organization selected by the user does not trust the certificate, the user can disable or delete the certificate.

1. Enter Application Settings, tap **Safety > Trusted Credentials**. There are two tabs in the Trusted Certificate screen:
  - System tab displays CA certificates installed in ROM.
  - User tab displays CA certificates installed by users.
2. Tap the certificate name to disable or delete it, and the certificate details screen will pop up.
3. Slide the screen down to the bottom, tap **Disable** (system certificates) or **delete** (user certificates).

If necessary, users can enable the disabled system certificate here. For deleted user certificates, users must reinstall it to enable it again.
4. Tap **OK**.



# Bluetooth communication

EDA60K-0 supports Bluetooth communication, allowing users to get connected with other Bluetooth-enabled devices.

Before searching for and connecting to other Bluetooth-enabled devices, users must enable the Bluetooth radio. By default, Bluetooth radio is disabled.

Bluetooth radio can be restored to its current state by system resetting. If users have reset the system data, they must re-establish the paired devices. Bluetooth status is displayed on the System Icon bar.

## Pairing with a Bluetooth-enabled device

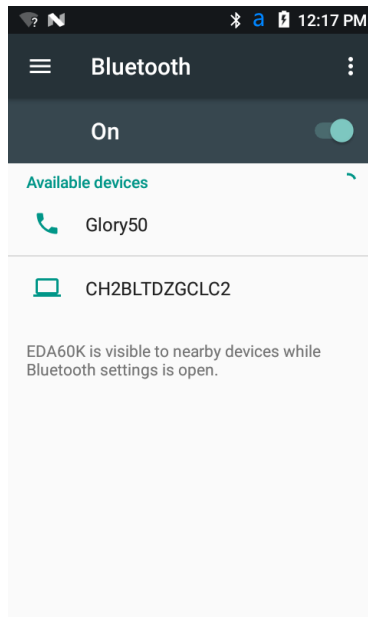

To connect to a Bluetooth-enabled device, users should enable Bluetooth radio first and then choose the device from the detected device list.

1. Enter Application Settings screen.
2. If Bluetooth switch is off, slide it on.
3. Tap **Bluetooth** to display available Bluetooth-enabled device list.

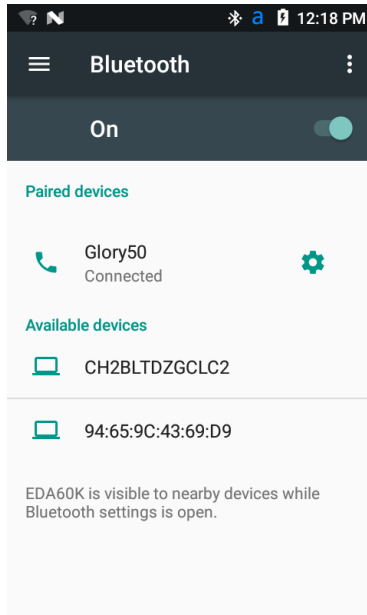

- (Optional) If the desired device is not listed, please check if the Bluetooth of that device has been enabled and is detectable, and then tap **Scan Device**.
- Select the device to pair with. After Pairing Dialog Box is displayed, enter the device PIN code, and tap **OK**. When the device and the Handheld Computers have been successfully paired, the device name will appear in the list of paired devices at the top.



- To disconnect with the paired device, tap the Quick Setting icon  beside the device name , and then tap Cancel Pairing.

## Configuring Bluetooth settings

Users can configure for Bluetooth in Application Settings.

1. Enter Application Settings screen, and tap **Bluetooth**.
2. Tap Menu icon  to select one for setting:
  - Tap Rename phone to change the name of the Handheld Computer. Enter a new name and then tap **Rename**.
  - Tap Visibility timeout to set the timeout duration for the Handheld Computer to be detectable, which is 2mins by default. Users can set it up as 5mins, 1hour or Never timeout. The shorter of the duration, the more power it could save.
  - Tap **Show received files** to view data in the received files.

## Renaming or disconnecting a paired device

Users can rename or disconnect a paired Bluetooth-enabled device in the Application Settings.

1. Enter Application Settings screen, and tap **Bluetooth**.
2. Tap **Settings** icon in the Paired List .
3. To rename the device, tap Rename, enter a new name and click **OK**.

To disconnect with this device, tap **Cancel Pairing**.

## Communication via serial port and USB

By communication via serial port and USB, users can transfer data to other devices or receive data from other devices with the following accessories.

- USB cable
- RS-232 cable

For more information about accessories, please contact local resellers.

# **6 Management and Maintenance**

This chapter introduces how to upgrade software, reset Handheld Computer and maintain EDA60K-0.

# Upgrading system software

The other system softwares of EDA60K-0 can be upgraded by downloading ".zip" files from the Technical Support Website. Website: [www.hsmcontactsupport.com](http://www.hsmcontactsupport.com) or [www.honeywellaidc.com](http://www.honeywellaidc.com).

## Upgrading AutoInstall application

1. Copy the upgrade file "EDA60K\_OTA\_XXXXX\_Update.zip" to the following EDA60K-0's system folder:
  - File Explorer\External Memory Card\honeywell\autoinstall
  - IPSM\honeywell\autoinstall
2. Tap **All Applications > AutoInstall Settings**.
3. Choose **Packages update**, and ScanPal EDA60K-0 will restart and install the upgrade file.

## Manually upgrading Recovery Menu

1. Copy the file "EDA60K\_OTA\_XXXXX\_Update.zip" to the root directory of the T card.
2. Turn off the Handheld Computer, press and hold the "Power Key" + "Volume+" key for about 15s, then the phone will enter Recovery Menu.
3. Press "Volume-", and select "Apply update from SD card". Press "Power Key", select the zip file just copied, then press and hold the "Power Key".
4. After the upgrading is completed, it will automatically move to Reboot System Now Menu. Please press the "Power Key" to restart the Handheld Computer.

# Restarting the Handheld Computer

If the Handheld Computer or an application is locked or doesn't respond when pressing the power key, you need to restart the Handheld Computer.

When restarting, the Handheld Computer will use the current configuration saved in the flash memory. Try the following ways to restart the Handheld Computer:

- **Restarting the system:** Restarts the Handheld Computer's operating system
- **Restarting hardware:** If there is no response after pressing the power button, hold it down for 13 seconds to force restart of the device
- **Restore default settings:** Clears all data in the Handheld Computer including all applications, data and files except built-in files or data in the movable storage device

## Restarting the system

When an application is not responding, you may need to restart the Handheld Computer to resolve the issue.

1. Save the file and close the application that has been opened already.
2. Press and hold 'Power Key' till the following interface displays:

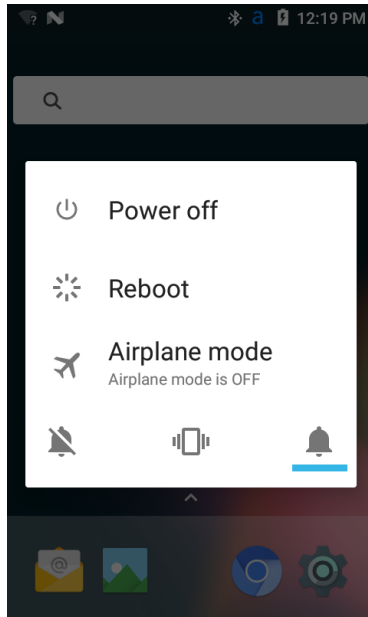

3. Tap **Power Off**.
4. Tap **OK** when message 'EDA60K-0 will shut down' pops up.
5. Press down 'Power Key' to restart EDA60K-0.

## Restart factory settings

If the Handheld Computer appears to be locked, try to cold boot. If resetting is invalid, try to restore factory settings, restart the Handheld Computer to make it work again and do troubleshooting later.



**Warning: This action will clear all data in the Handheld Computer, including all applications and data, but excluding data stored in flash memory or external storage device.**

1. Tap **All Applications > Settings**.
2. Tap **Backup & Reset**.
3. Tap **Restore Factory Settings**.
4. Tap **Reset the Phone**.
5. EDA60K-0 will restart and automatically clear user data.

# 7 Specifications

## Physical and Environment Specifications

This chapter provides the physical and environment specifications of EDA60K-0.

### Product Outline Dimensions

Length	215.5mm
Width	78.5 mm
Thickness	28 mm
Weight (with battery)	415 g (with battery)

### Tumble and drop standards

Tumble	200 tumbles within 0.5m
Drop	Multiple 1.2m drops to concrete at room temperature

### Power and electrical specifications

Battery	Rechargeable Li-ion battery, 3.7V, 5100 mAh
Charging power	5 V, 2 A

### Temperature and humidity specifications

Operating temperature	-10 °C ~ 50 °C (14 °F ~ 122 °F)
Storage temperature	-20 °C ~ 60 °C (-4 °F ~ 140 °F)
Relative humidity (during operation)	10%-90% condensate-free



## **Display specifications**

4.0-inch color LCD/WVGA pixel/full-perspective/capacitive touch screen

## **Language Support**

Not limited to WW English, French, German, Italian, Spanish, Simplified Chinese and Traditional Chinese.

## **Symbolgies support**

The following symbologies are supported:

### **1D codes:**

- Codabar
- Code 3 of 9
- Code 11
- Code 32
- Code 93
- Code 128
- EAN-8
- EAN-13
- GS1-128
- Korea Post
- IATA 2 of 5
- Industrial 2 of 5
- Interleaved 2 of 5
- ISBN
- ISBT 128
- Matrix 2 of 5
- MSI Plessey
- EAN.RCC (RSS-14)
- RSS Limited
- RSS Expanded

- Telepen
- Trioptic Code
- UPC-A
- UPC-E

**Postcode**

- Australia postcode
- Canada postcode
- Netherlands Postal Codes (KIX)
- Japan postcode
- UK Postal code
- Planet Code
- Postnet
- UsIntelligent
- Info mail
- UPU(ID-tag)

## Scan Depth of Field (DOF)

DOF performance of the product was measured under the following conditions:

- DOF is the distance from the top of scan engine to the barcode
- 23 °C (73 °F), 0 ~ 10K lux
- Clear, high quality barcodes



**Note: If the barcode is not aligned well with the scan engine, reading time and depth of field (DOF) will be affected and the device performance will be decreased.**

*Note1: EDA60K-0 has N4313 and N5603 versions with different OCR functions due to different configurations. The following table shows the data of N4313. Different engine DOFs are significantly different, and shall be subject to actual measurement data.*

	Short (in/cm)	Long (in/cm)	Increments (in/cm)
5mil code39/128	3.7 (9.4)	7.1 (18.1)	3.4 (8.7)
13mil UPC-A	2.0 (5.2)	16.2 (41.1)	14.2 (36.1)
40mil Code39	3.7 (9.3)	27.6 (70.0)	23.7 (60.7)

## **Honeywell Scanning & Mobility**

9680 Old Bailes Road

Fort Mill, SC 29707

[www.honeywellaidc.com](http://www.honeywellaidc.com)

ScanPal Series EDA60K Mobile Computer for Android User Guide

P/N EDA60K-SC-UG Rev.A